

*Ultrahigh Accuracy &  
Temperature Measurement*

# **Calorienna**®

*The Ultrasonic Flow Meter*



● MADE IN JAPAN

# Caloriена

## Characteristics

The “Caloriена” is the world’s first Ultrasonic Flow Meter that enables simultaneous measurement of flow rate (velocity) and liquid temperature within the piping, from outside the pipeline.

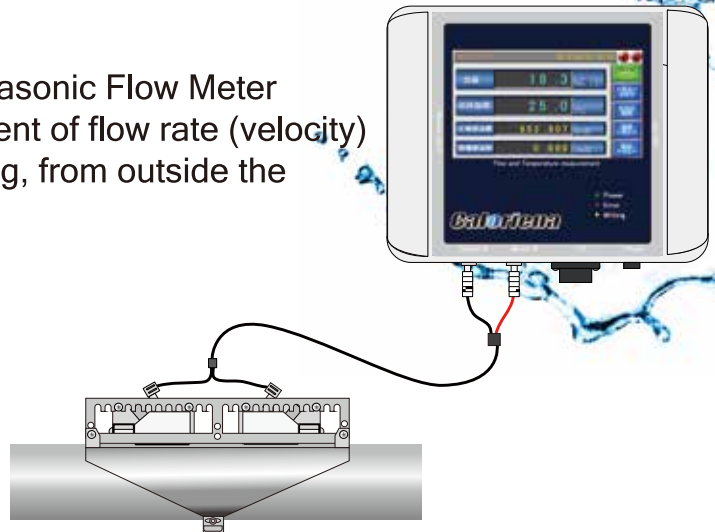
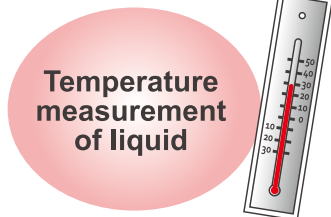

## 6 Unique features of Caloriена

### Fast & Easy Installation

Portable and battery operated, installation is simple. Just clamp the device onto the pipe with only 1 screw or velcro straps. Calibration and adjustments are fully automated. There is no need for engineers.



### Ultra-high Resolution

Even more accurate with minute flows.  
(From 0.001m/sec at >DN200, 0.6% for RD at >0.5m/sec.)

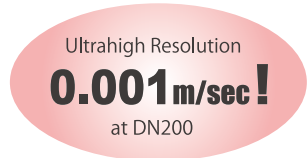

### Dynamic Auto-tuning

Dynamic Auto-tuning enables the user to calibrate without stopping the flow. The controllers are able to automatically adjust or cancel zero offsetting, making installation even easier.

### Auto Wall thickness Detection

This feature will let you know the pipe wall thickness, when thickness is not known or cannot be measured due to corrosion.

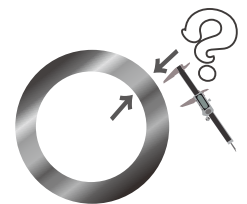

### Extremely Compact

V1-type:	V2-type:
H 28.0mm	H 28.0mm
W 25.5mm	W 25.5mm
L 148.0mm	L 250.0mm

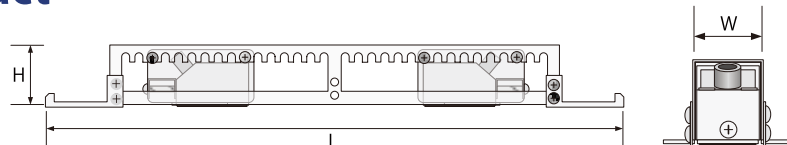

### MODBUS

Besides storing data onto a memorycard, there is also an option to monitor with a computer by directly connecting it to the controller.





CONTROLLER  
H130xW160xD60  
Excluding protusions



Water Resistant Cover

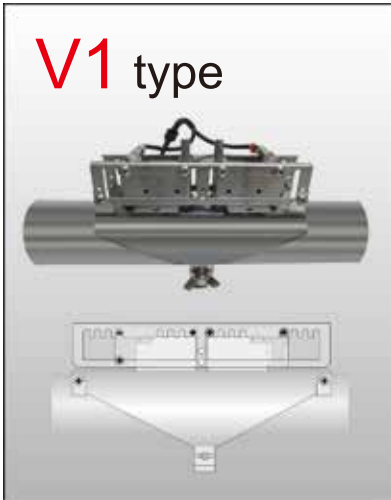

V1 type



V2 type

## ■ General Specifications

Item	Standard
Fluid to be Measured	Water, Pure Water, etc.
Piping Material	Carbon Steel, Stainless Steel, Vinyl Chloride, Copper, Aluminium, Hard Vinyl, Acrylic, Polyethylene, Cast Iron, Other
Applicable Pipe Sizes	DN25~DN300 (1"-12")
Measuring Range	0.000~5.000 [m/sec]
Velocity Resolution	0.001[m/sec] / >DN200, 0.003[m/sec] / <DN200
Measurement Accuracy	±0.6% for RD (at a flow rate of 0.5 [m/sec] or more) ±2% for RD (at a flow rate less than 0.5 [m/sec])
Fluid Temperature Measurement Range	0.0~50.0[°C] accuracy ±1.0[°C]

## ■ Specifications for Controller Section

Item	Standard	
Supply Voltage & Power Consumption	DC24V (or DC5V-DC26V Battery-powered), approx.3W	
Man-Machine Interface	4.3" Liquid Crystal Touch Panel	
Analog Output	Ch1 (Flowrate)	DC 4-20mA (DC0-24mA) (Resistance ≤ 500Ω)
	Ch2 (Temperature)	DC 0-5V
Digital Output DC30V 1A	Ch1 PhotoMOS	Positive Flow Rate Pulse
	Ch2 PhotoMOS	Negative Flow Rate Pulse
	Ch3 Mechanical Relay	Measurement Error (ERROR)
Recording Medium	SD Card	
Communication*	RS485 (MODBUS RTU)	9,600~38,400bps
Calendar Clock	Built-in Circuit Board	
Installation Method	With Screws or DIN Rail	
Working Temperature Range	0 ~ 45°C	

\*Optional: cannot be used while recording media

## ■ Specifications for Sensor Section

Item	Standard
Sensor	Ultrasonic Wave Transducer
Installation Method	One-Screw Bracket or Velcro Straps

Fittings	Pipe Size	Sensor Type	Minimum Flow Velocity Resolution [m/sec]
	DN 25 (1")	V1 type	0.007
DN 32 (1¼")	0.006		
DN 50 (2")	0.003		
Fittings	DN 80 (3")	V2 type	0.002
	DN 100 (4")		0.003
	DN 150 (6")		0.002
	DN 200 (8")		0.001
	DN 300 (12")		0.001
Water-Proof Performance	IP55		Under certain conditions

The Ultrasonic Flow Meter  
**Caloriена**  
 Examples of Application

As a calorimeter for better energy management

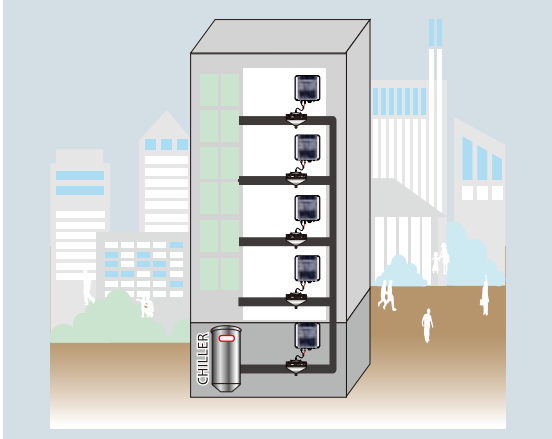

At a bottling factory



Various Monitoring methods

With Smartphone by Bluetooth



MODBUS With \*QuickPanel®

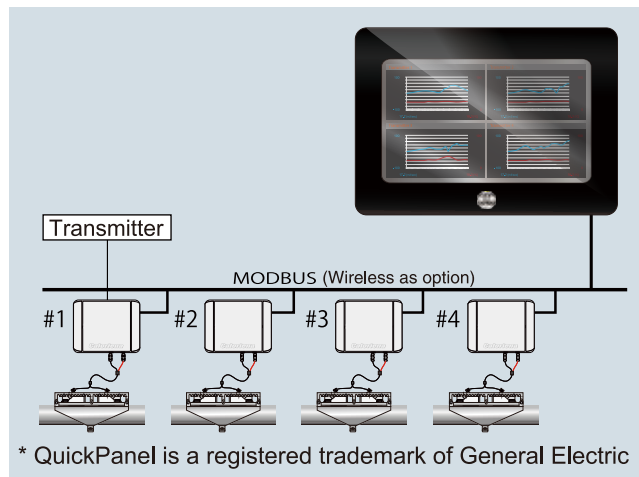

■ You may also be interested in



**NINJA**  
 Direct-insertion  
 Ultrasonic Flow Meter

Contact



**ict co.,ltd.**

7-7-6 AO Matsubara City, Osaka JAPAN 580-0043  
 Phone +81 72-336-2311 Fax +81 72-336-2312

<http://www.ict-osaka.net>

Email: [info\\_global@ict-osaka.com](mailto:info_global@ict-osaka.com)

**Caloriена** is a registered trademark of ICT Co.,Ltd.